

# gogo Kidz® Travelmate

## Safety & Operating Instructions



Model QRKIDZ

Go-Go Babyz® Corporation

## Warranty

### EXPRESS LIMITED WARRANTY

Go-Go Babyz Corporation (“Go-Go Babyz”) warrants this product to be free from defects in materials and workmanship for a period of one year from the date of purchase. Go-Go Babyz will repair or replace, at its sole option, the defective product within that one-year time period.

If you have a problem with your Go-Go Babyz product or are not satisfied with it, please contact Go-Go Babyz Customer Service at 1.888.686.2552.

This express limited warranty does not cover:

- (1) Pick-up, delivery, or freight charges.
- (2) Corrosion caused by improper storage or failure to reasonably protect the product from salt water and adverse conditions.
- (3) Deterioration due to lack of maintenance and cleaning as specified in the product instructions.

Go-Go Babyz SHALL NOT BE LIABLE FOR ANY INCIDENTAL OR CONSEQUENTIAL DAMAGES ARISING FROM BREACH OF ANY EXPRESS OR IMPLIED WARRANTY ON THIS PRODUCT. ANY IMPLIED WARRANTY, INCLUDING IMPLIED WARRANTIES OF MERCHANTABILITY AND FITNESS FOR A PARTICULAR PURPOSE, IS LIMITED TO THE DURATION OF THE EXPRESS, LIMITED WARRANTY (ONE-YEAR FROM THE DATE OF PURCHASE).

Under no circumstance shall any liability of Go-Go Babyz under this Express Limited Warranty, or otherwise, exceed the price of the defective product or parts.

Note: Some states do not allow the exclusion or limitation on incidental or consequential damages, so the above limitation may not apply to you. Some states do not allow limitations on how long an implied warranty lasts, so the above limitation may not apply to you.

This Express Limited Warranty gives you specific legal rights, and you may have other rights, which vary from state to state.

CONTACT GO-GO BABYZ' CUSTOMER SERVICE FOR INFORMATION AND ALL RETURNS:

Go-Go Babyz Returns  
7013 Realm Drive, Suite C  
San Jose, CA 95119  
408.360.0653

**Table of Contents**

Safety..... 4  
Assembly Instructions ..... 6  
Step by Step Attaching Instructions..... 7  
Quick Release Strap Adjustments ..... 8  
Commercial Airlines, Car Seats and the gogo Kidz Travelmate ..... 9  
Care and Maintenance ..... 10

## Safety

**DO NOT USE** the gogo Kidz® Travelmate until you read and understand these instructions. Your child's safety depends on you reading and following these instructions.

 **WARNING: NEVER LEAVE CHILD UNATTENDED.**

 **WARNING: AVOID SERIOUS INJURY FROM FALLING OR SLIDING OUT. ALWAYS USE CAR SEAT RESTRAINT SYSTEM.**

Be sure to follow the manufacturer's instructions on how to properly secure your child in their car seat.

 **WARNING: DO NOT EXCEED WEIGHT AND SIZE LIMITATIONS OF THE CAR SEAT MANUFACTURER OR 50 LBS. MAXIMUM.**

This product is to be used as an add-on to your toddler car seat. The warnings and instructions are in addition to the safety manual provided by your car seat manufacturer.

 **WARNING: DO NOT LEAVE THE GOGO KIDZ ATTACHED TO A CAR SEAT WHILE DRIVING IN AN AUTOMOBILE. THE GOGO KIDZ HAS NOT BEEN TESTED IN COMBINATION WITH THE CAR SEATS IN ANY CRASH TESTING PROGRAM AND INJURY TO YOUR CHILD COULD OCCUR.**

 **WARNING: TO AVOID INJURY, KEEP CHILD AWAY FROM TELESCOPING HANDLE. THIS IS NOT A TOY.**

 **WARNING: ALWAYS ENSURE THE GOGO KIDZ TRAVELMATE IS SECURELY ATTACHED TO THE CAR SEAT.**

Injury to your child could result if the unit were to come off accidentally when traveling with your child.

 **WARNING: DO NOT USE WHILE EXERCISING**

Do not use this product while running, jogging, in-line skating or participating in other athletic activities.

 **WARNING: EXCESSIVE WEIGHT, PARCELS, OR ACCESSORY ITEMS PLACED OR HUNG ON THE HANDLE MAY CAUSE THE UNIT TO BECOME UNSTABLE.**

Do not place parcels or accessory items on the handle in excess of 3 pounds.

Do not allow children to play with or hang onto the gogo Kidz Travelmate.

 **WARNING: DO NOT ALLOW CHILDREN TO CLIMB INTO OR OUT OF THE CAR SEAT WHILE GOGO KIDZ IS SECURED, UNLESS YOU ARE HOLDING THE GOGO KIDZ TRAVELMATE AND INSTRUCTING THE CHILD.**

 **WARNING: NEVER USE THE GOGO KIDZ TRAVELMATE ON STAIRWAYS OR ESCALATORS.**

 **WARNING: THE GOGO KIDZ TRAVELMATE IS DESIGNED TO ROLL**

Make sure the front of the car seat is on the floor and the entire unit is on a flat surface before letting go of the handle.

Accessories which are not approved by the manufacturer or distributor should not be used.

 **WARNING: PLASTIC MATERIAL WILL WEAKEN OVER TIME IF EXPOSED TO EXCESSIVE HEAT OR LIGHT. USE OF THIS PRODUCT SHOULD BE DISCONTINUED 5 YEARS FROM THE DATE OF MANUFACTURER, AS SHOWN ON THE PRODUCT.**

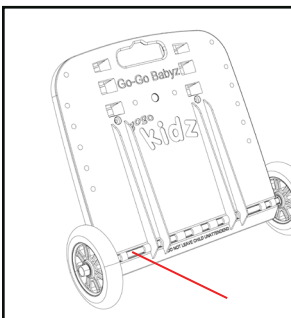
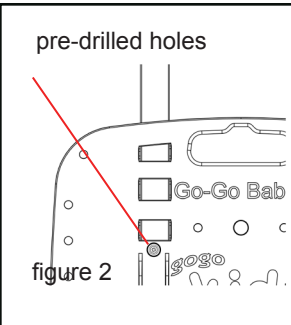
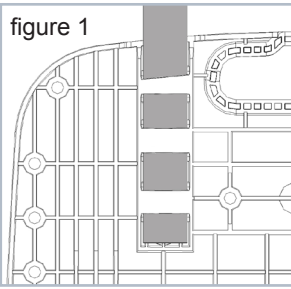
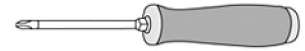

figure 3 - axle guide

\*You will need a Phillips Head Screwdriver or electric drill for handle screws

1. Insert handle into plate. (figure 1)
2. Align pre-drilled holes at the bottom of the handle with holes in front of plate (It is okay if holes do not align perfectly they are to be used as a guide). (figure 2)
3. Insert handle screws in front of plate with the screwdriver.
4. Pull up on handle to ensure it is secured.
5. Insert axle through opening at bottom of plate. (figure 3)
6. Slide wheel with quick release spring locks on to each side of axle, push on spring until wheel snaps in place.
7. Test connection by pulling on wheels to ensure they are secured.

### RECOMMENDED CAR SEATS

The gogo Kidz® Travelmate will accommodate most convertible and toddler car seats. Please refer to the list of recommended car seats, located on the back of the product box, to ensure a safe fit. You may also visit [www.gogobabyz.com](http://www.gogobabyz.com) for our compatibility list. Go-Go Babyz is continually testing new seats with the gogo Kidz and will update our web site frequently whenever we discover a new match or to confirm which seats will not fit with the gogo Kidz. If you do not see your car seat listed on the product box, please check our web site ([www.gogobabyz.com](http://www.gogobabyz.com)) to see if we have had to opportunity to test it with the gogo Kidz.



figure A  
Arrows pointing to car seat ribs

## Instructions for attaching your gogo Kidz Travelmate to your car seat.

**NOTE:** The Quick Release Strap is pre-assembled onto the plate of the gogo Kidz Travelmate for use with most car seats. However, you may need to make adjustments in the length of the strap or the vertical position of the strap on the gogo Kidz plate. (to fit your particular car seat, see quick release strap adjustments on next page)

1. Place car seat face down on floor (after the first time you attach and are familiar with the product, you may also attach the gogo Kidz Travelmate to a car seat while in an upright position and with a child sitting in seat).
2. Locate the two ribs on each side of your car seat (figure A page 6)
3. Align the two support tabs at the bottom of the gogo Kidz plate with the bottom ribs (or the bottom of base). (figure B)
4. Lay the gogo Kidz plate flat on top of the back of car seat. (figure C)
5. Take the ladder strap (long side of the strap - already attached to the gogo Kidz plate) and insert through the same opening where you would put your car seat belt through in the forward position. (figure D)
6. Insert ladder strap into the buckle located on the opposite side of the gogo Kidz plate and use ratchet to tighten. Tighten securely, but DO NOT OVERTIGHTEN. (figure D)
7. Pick up your car seat and place in the upright position.
8. Test connection by releasing the handle into the upright position and pulling/pushing your seat around the room.
9. If your car seat has a tether strap, pull 10" of the strap out and pull through the handle and attach tether latch to plate handle, tighten strap to ensure the gogo Kidz Travelmate is secure (figure E) This is especially recommended for use with older children.

### SPECIAL NOTES

**Support Tabs Under Base vs Ribs:** Some car seats do not have these two long ribs in the back. For these types of seats, the support tabs on the bottom of the gogo Kidz should be located underneath the base itself.

**Reclining Seats:** The seat recline angle may have to be adjusted in order to make room for the support tabs or the wheels to fit on some car seats.

**Britax Seats:** Do not place the support tabs underneath the base on Britax car seats. You must place tabs on the car seat under the ribs on Britax car seats.

**Removable Base:** If your car seat has a removable base, you may need to remove the base prior to attaching the gogo Kidz Travelmate.

**Headrest Adjustment:** You may be required to move the bar on the back of your car seat that adjusts the shoulder straps (if equipped) to allow the handle to sit properly.

## Attaching Instructions

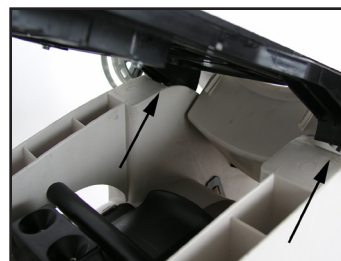

figure B  
Arrows pointing to support tabs

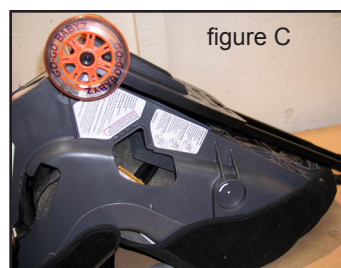

figure C  
Make sure tabs align with ribs at the bottom of the car seat. Use opening if available

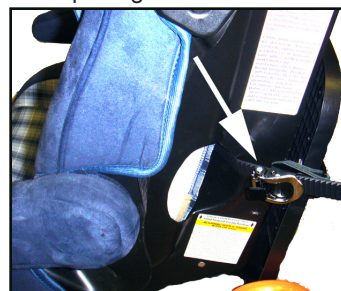

figure D - ladder strap & ratchet

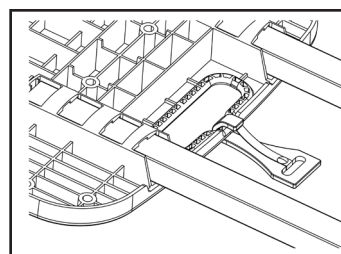
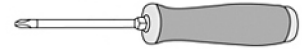

figure E  
Attaching the tether clip to the

## Quick Release Strap Adjustments

### Quick Release Strap Adjustments



**NOTE:** The Quick Release Strap on the gogo Kidz has been assembled in the most common position, to fit most car seats. Once the gogo Kidz Travelmate has been properly attached to a car seat, it should not move or slide around. Your car seat should easily roll freely once tilted back on the gogo Kids Travelmate wheels. If not, please adjust either the length of the strap for more tension or the position of the strap on the gogo Kidz Travelmate. The strap should be level with the forward facing car seat belt opening.

**TO ADJUST TENSION:** Slide the strap adjusting clip to the left or right to tighten or loosen the strap as needed.

**TO ADJUST THE STRAP HEIGHT:** Remove the metal brackets that attach the strap to the gogo Kidz Travelmate plate with a screwdriver. Reposition the bracket in holes running down the side of the gogo Kidz Travelmate plate.

**NOTE:** Make sure you position both metal brackets in the same hole on each side (ex: left side is third hole from the top and right side is third hole from the top).

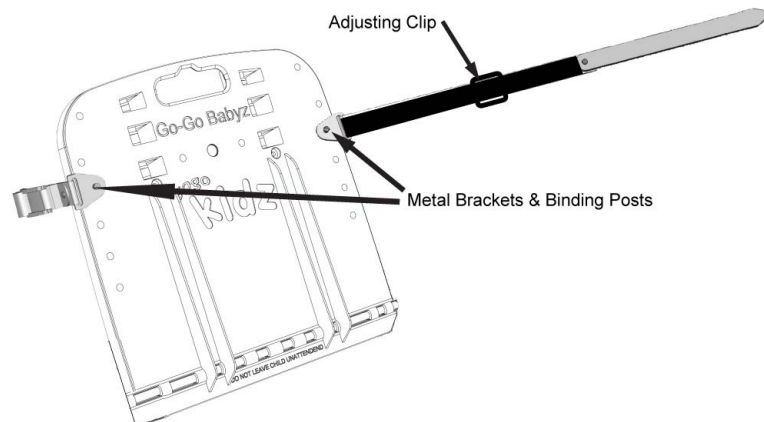

**Does the gogo Kidz® Travelmate fit down the aisle of an airplane? Can I leave it attached on an airplane? Any suggestions about the car seat and the airplanes?**

**Going Through Security**

Some x-ray machines at the airport may be smaller and your car seat with the gogo Kidz Travelmate attached may not fit through the machine. We suggest asking the Security Personnel to "hand wand" your car seat with the gogo Kidz attached just like a stroller. Model QRKIDZ has quick release wheels so if needed you can remove the wheels to allow your car seat to fit through the smaller machines.

**Airplane Aisles**

The gogo Kidz is 16 ½ inches wide and fits down the aisle of most commercial airplanes. However, many car seats are wider and they may not fit down the aisle of the coach section. A practical approach is to have your child out of the seat and expect to carry the seat to your assigned seat, once you reach the coach section. The handle in the down, locked position on the gogo kidz makes this easier to do than carrying the car seat by itself.

**Airplane Seats**

There are dozens of car seat manufacturers with multiple models of car seats. **THE GOGO KIDZ® TRAVELMATE HAS NOT BEEN TESTED IN COMBINATION WITH THE CAR SEATS IN ANY CRASH TESTING PROGRAM.** We advise that you remove the gogo Kidz and either stow it in the overhead bin or "gate check it." Fortunately, the gogo Kidz is very easy to put on and take off.

NOTE: If you do choose to keep the gogo Kidz Travelmate attached to your car seat during flight, there have been reports of the aircraft seat belt buckle being stuck behind car seats, creating a removal problem at destination. You may wish to ask the flight attendant for a seat belt extender to eliminate the potential for this problem.

NOTE: As your child grows and you no longer use your car seat during flight, we recommend that you use the gogo Kidz Travelmate through the airport and gate check your car seat and gogo Kidz Travelmate.

**Other Airplane Information**

We are updating our web site, [www.gogobabyz.com](http://www.gogobabyz.com), to include information and links that offer some very good general information about traveling with children on airplanes, safety issues and other practical suggestions. We recommend you take the time to review this information.

## Care & Maintenance

Before connecting the gogo Kidz Travelmate to your car seat, make sure the unit is assembled correctly and all parts and fasteners are secure.

After assembly, pull horizontally on the back of the gogo Kidz to make certain the guides are aligned properly and there is no slippage.

Periodically check that the handle, axle and wheels are secure.

Replace any damaged parts immediately.

Clean with a damp cloth and wipe dry.

Do not store unit outside exposed to rain or extreme sunlight.

Do not place heavy items on top of unit when storing it.



**WARNING: PLASTIC MATERIAL WILL WEAKEN OVER TIME IF EXPOSED TO EXCESSIVE HEAT OR LIGHT. USE OF THIS PRODUCT SHOULD BE DISCONTINUED 5 YEARS FROM THE DATE OF MANUFACTURER, AS SHOWN ON THE PRODUCT.**

**Thank you!**

Thank you for your recent order. We wish you many happy travels with your new gogo Kidz® Travelmate!

Our goal for Go-Go Babyz is to offer innovative, high quality and safe products to make life easier when you and your baby are “on the go.”

We welcome suggestions and comments. Go-Go Babyz is dedicated to making our current products and features easier to use. Please send ideas for new features, products or general feedback to us at [info@gogobabyz.com](mailto:info@gogobabyz.com).

In addition, we have created a photo gallery on our web site for families, like us, using Go-Go Babyz products. Please feel free to email or mail us any photos of you and your children using our products and we would be happy to share them on our Family Photo Gallery page.

Thank you again for your purchase. We appreciate your business.

Sincerely,

The Go-Go Babyz Family

Toll Free: 888.686.2552

[www.gogobabyz.com](http://www.gogobabyz.com)

